



## Specification & Installation instruction



### Feature:

- Power supply high voltage 120 or 240 VAC.
- Clutch for manual adjustments.
- Maintenance free.
- Position indicator.
- Fail safe by *Enerdrive System*<sup>1</sup> (on model 360 & 380).
- Auxiliary switches (on model 320 & 380).

### Old Number

TBTHV3300A	TT300
TBTHV3305A	TT305
TBTHV3321A	TT320
TBTHV3360A	TT360
TBTHV3365A	TT365
TBTHV3380A	TT380
RBTHV5300A	RT300
RBTHV5305A	RT305
RBTHV5321A	RT320
RBTHV5360A	RT360
RBTHV5365A	RT365
RBTHV5380A	RT380

Technical Data	TT300 TBTHV 3300A	TT305 TBTHV 3305A	TT320 TBTHV 3321A	TT360 TBTHV 3360A	TT365 TBTHV 3365A	TT380 TBTHV 3380A	RT300 RBTHV 5300A	RT305 RBTHV 5305A	RT320 RBTHV 5321A	RT360 RBTHV 5360A	RT365 RBTHV 5365A	RT380 RBTHV 5380A
<b>Auxiliary switches</b>	No	No	Yes(2)	No	No	Yes (2)	No	No	Yes(2)	No	No	Yes (2)
<b>Feedback</b>	No	Yes	No	No	Yes	No	No	Yes	No	No	Yes	No
<b>Fail safe - Enerdrive</b>	No			Yes			No			Yes		
<b>Power consumption</b>	10 VA			30 VA Peak, 10 VA			14 VA			30 VA Peak, 14 VA		
<b>Control signal</b>	3 wire / 2 position, 3 wire / 3 point floating			2 wire / 2 position, 4 wire / 3 point floating			3 wire / 2 position, 3 wire / 3 point floating			2 wire / 2 position, 4 wire / 3 point floating		
<b>Weight</b>	5 lbs. [2.3 kg]						8 lbs. [3.5 kg]					
<b>Torque</b>	180 in.lb. [20 Nm] at rated voltage						360 in.lb. [40 Nm] at rated voltage					
<b>Running time through 90°</b>	60 to 85 sec Torque dependant											
<b>Power supply</b>	110 to 130 VAC or 220 to 250 VAC 50/60Hz											
<b>Electrical connection</b>	18 AWG [0.8 mm <sup>2</sup> ] minimum											
<b>Inlet bushing</b>	2 inlet bushing of 7/8 in [22.2 mm]											
<b>Angle of rotation</b>	0 to 90 degrees, mechanically adjustable with SLD (optional), (factory set with 90° stroke)											
<b>Direction of rotation</b>	Reversible, Clockwise (CW) or Counterclockwise (CCW) (factory set with CW direction)											
<b>Ambient temperature</b>	0°F to +122°F [-18° C to +50° C]											
<b>Storage temperature</b>	-22°F to +122°F [-30° C to +50° C]											
<b>Relative Humidity</b>	5 to 95 % non condensing.											

Warning: Do not press the clutch when actuator is powered

### Dimensions

Dimension	Inches	Metric (mm)
A	5.20	132.1
B	1.33	33.8
C	9.13	231.9
D	3.55	90.2

### Caution

We strongly recommend that all neptronic® products be wired to a separate transformer and that transformer shall service only neptronic® products. This precaution will prevent interference with, and/or possible damage to incompatible equipment.

When multiple actuators are wired on a single transformer, polarity must be observed. Long wiring runs create voltage drop which may affect the actuator performance.

<sup>1</sup> Enerdrive System U.S.A. Patent #5,278,454



Mechanical installation

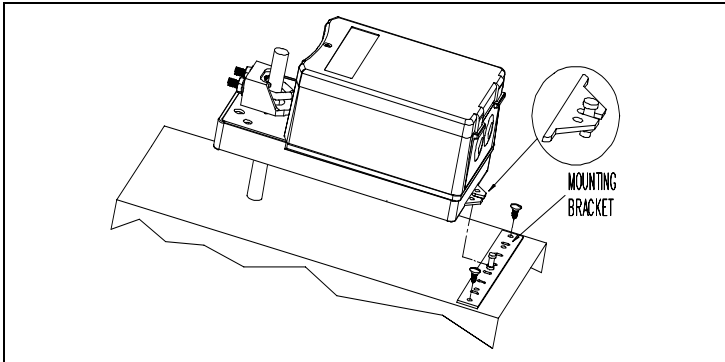

1. Manually close the damper blades and positioned the actuator at 0° or 90°.
2. Slide the actuator onto the shaft.
3. Tighten the nuts on the “U” bolt to the shaft with a 10mm wrench to a torque of 150 in.lb. [17 Nm].
4. Slide the mounting bracket under the actuator. Ensure free movement of the slot at the base of the actuator. The bracket pin must be placed in the mid distance of the slot.
5. Fix the bracket to the ductwork with #8 self-tapping screws.

Wiring Diagrams

Models TT300, 305 & 320  
RT300, 305 & 320

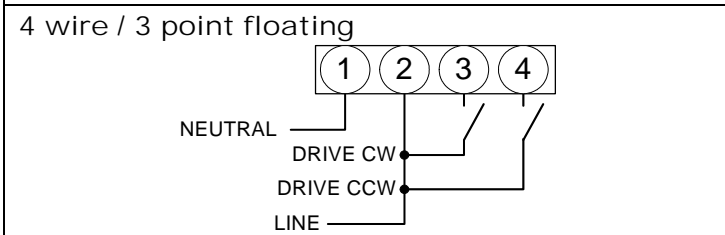
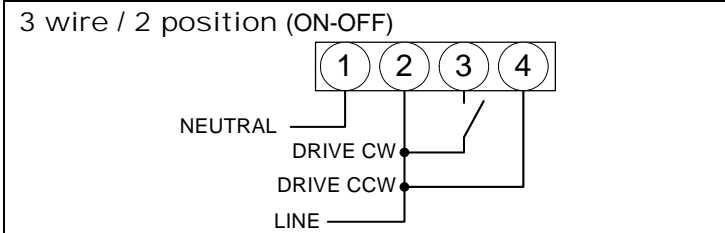

Models TT360, 365 & 380  
RT360, 365 & 380

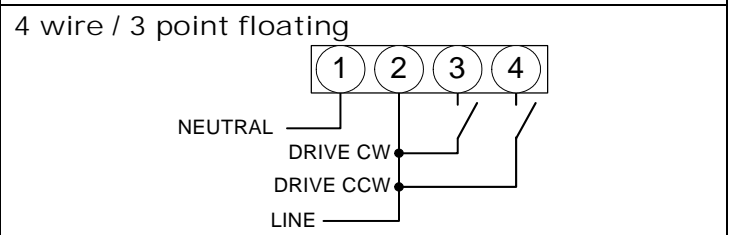
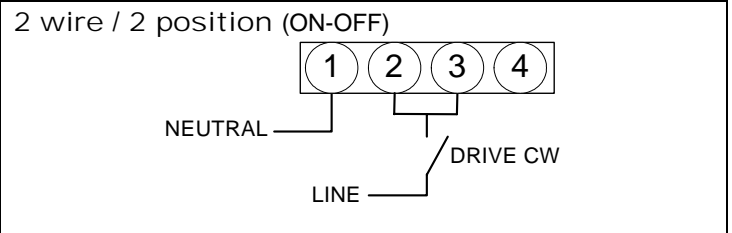

PC Board

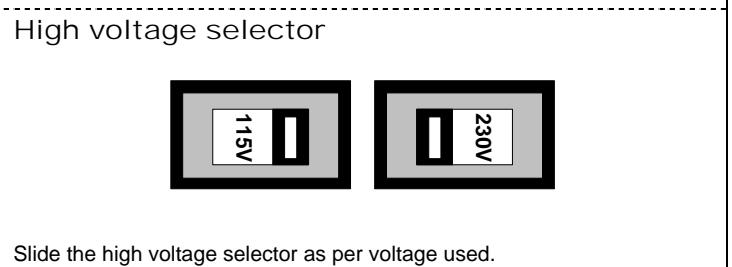
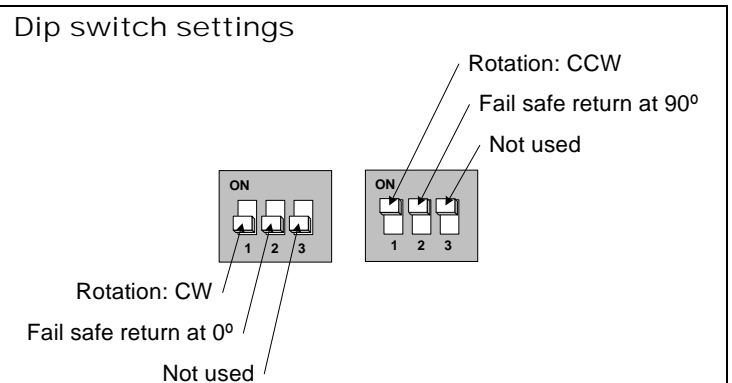
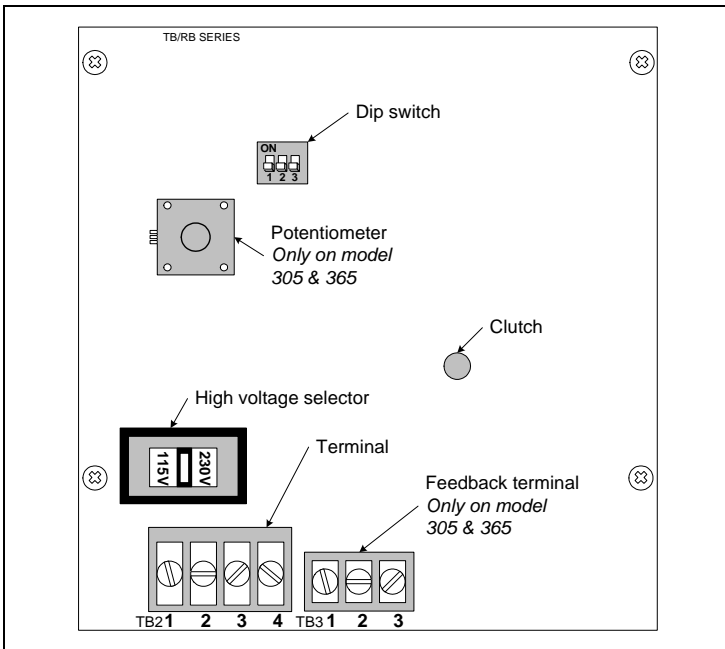

Stroke adjustment

To adjust the stroke, use the stroke limiting device (SLD). (not included)