

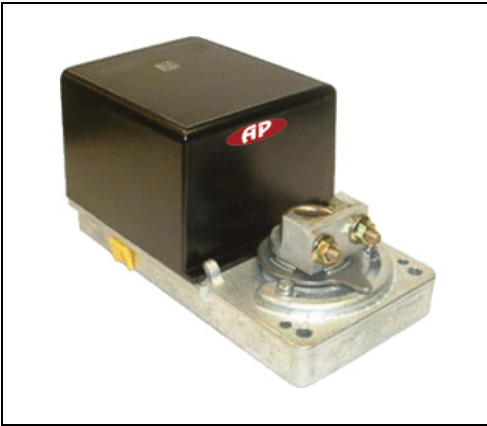

Actuator Specification & Installation Instructions



Feature:

- Mounts easy on round & square shaft (with option -8).
- External clutch for manual adjustments.
- Maintenance free.
- Position indicator.
- Control signal fully programmable.
- Auto stroke on power up
- Brushless DC driven motor.
- Fail safe by *Enerdrive System*¹ (on model 060).
- Auxiliary switches (on model 020)

BM000N
BM020N
BM060N
BM000FN
BM020FN
BM060FN
BM000FFN
BM020FFN
BM060FFN

Technical Data	BM000N	BM000FN	BM000FFN	BM060N	BM060FN	BM060FFN	BM020N	BM020FN	BM020FFN
Running time through 90°	15 sec	6 sec	3 sec	15 sec	6 sec	3 sec	15 sec	6 sec	3 sec
Power consumption	10 VA	10 VA	10 VA	18VA Peak, 10VA	18VA Peak, 10VA	18VA Peak, 10VA	10 VA	10 VA	10 VA
Torque	50 in.lb. [5,6 Nm] at rated voltage		35 in.lb. [3,9 Nm] at rated voltage	50 in.lb. [5,6 Nm] at rated voltage		35 in.lb. [3,9 Nm] at rated voltage	50 in.lb. [5,6 Nm] at rated voltage		35 in.lb. [3,9 Nm] at rated voltage
Fail safe - Enerdrive	No			Yes			No		
Auxiliary switches	No						Yes (2)		
Ingress protection	IP22 equivalent to Nema type 2, IP54 equivalent to Nema type 3R if water tight inlet bushings (not supplied NEP617) are installed						IP22 equivalent to Nema type 2		
Feedback	4 to 20 mA or 2 to 10 VDC adjustable (default setting: 4 to 20mA)								
Power supply	22 to 26 VAC or 28 to 32 VDC								
Electrical connection	18 AWG [0.8 mm ²] minimum								
Inlet bushing	2 inlet bushing of 5/8 in [15.9 mm] & 7/8 in [22.2 mm]								
Control signal	Analog, Digital or Pulse with modulation (PWM) programmable (default setting: Analog control signal)								
Angle of rotation	0 to 90 degrees, mechanically adjustable (default setting: 90° stroke)								
Direction of rotation	Reversible, Clockwise (CW) or Counterclockwise (CCW) (default setting: CW direction)								
Ambient temperature	-22°F to +122°F [-30° C to +50° C]								
Storage temperature	-22°F to +122°F [-30° C to +50° C]								
Relative Humidity	5 to 95 % non condensing.								
Weight	3 lbs. [1.4 kg]								

Warning: Do not press the clutch when actuator is powered

Dimensions

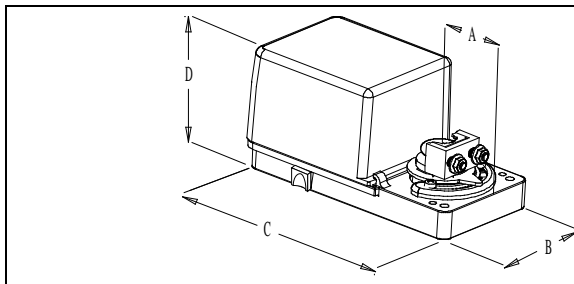

Dimension	Inches	Metric (mm)
A	1.50	38.1
B	3.26	82.8
C	6.60	167.5
D	model 000 & 060	3.01
	model 020	3.72

Caution

We strongly recommend that all Neptronic[®] products be wired to a separate transformer and that transformer shall service only Neptronic[®] products. This precaution will prevent interference with, and/or possible damage to incompatible equipment.
When multiple actuators are wired on a single transformer, polarity must be observed. Long wiring runs create voltage drop which may affect the actuator performance.

¹ Enerdrive System U.S.A. Patent #5,278,454



Mechanical Installation

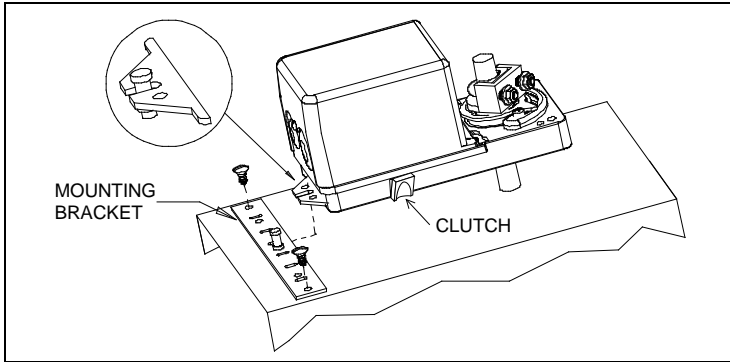

1. Manually close the damper blades and positioned the actuator at 0° or 90°.
2. Slide the actuator onto the shaft.
3. Tighten the nuts on the “U” bolt to the shaft with a 8mm wrench to a torque of 60 in.lb. [6,7 Nm].
4. Slide the mounting bracket under the actuator. Ensure free movement of the slot at the base of the actuator. The bracket pin must be placed in the mid distance of the slot.
5. Fix the bracket to the ductwork with #8 self-tapping screws.

Wiring Diagrams

Analog or PWM

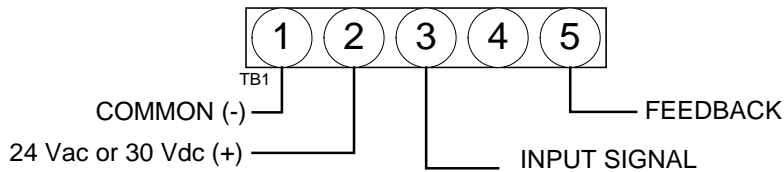

Digital signal

Digital - 3 wire / 2 position

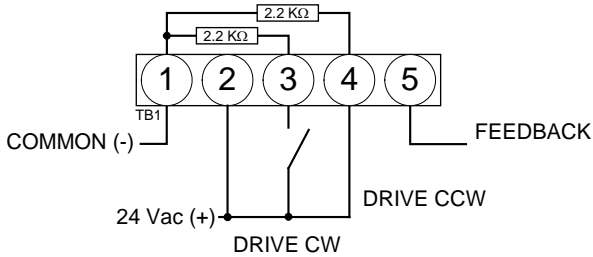

Digital - 4 wire / 3 point floating

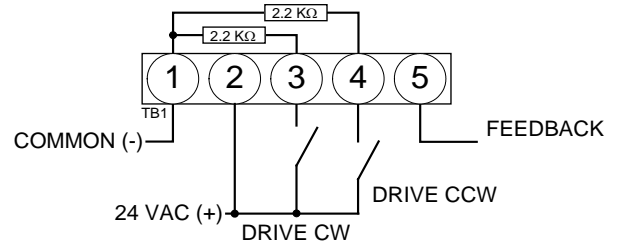

Special consideration for Digital control

In this mode, the actuator is sensitive to induced electrical voltages **from external sources**. To prevent such interference, if the signal on pins 4 and 3 on TB1 are from an **external 24 Vac source**, install a resistor 2.2kohm, 0.5W between pins 4 and 1 and another of 2.2kohms, 0.5W between pins 3 and 1 of TB1. These resistors are included.

Input Signal and Feedback setup

	Input Signal	Feedback
Analog Mode	Input Signal is set with Dipswitch # 3 DS1-3 at OFF = 2 – 10Vdc (default setting) DS1-3 at ON = 4 – 20mA	Feedback is set with Dipswitch #4 DS1-4 at OFF = 4 – 20mA (default setting) DS1-4 at ON = 2 – 10Vdc
Digital & PWM Mode	No Input Signal Setting DS1-3 MUST be at OFF	

PC Board

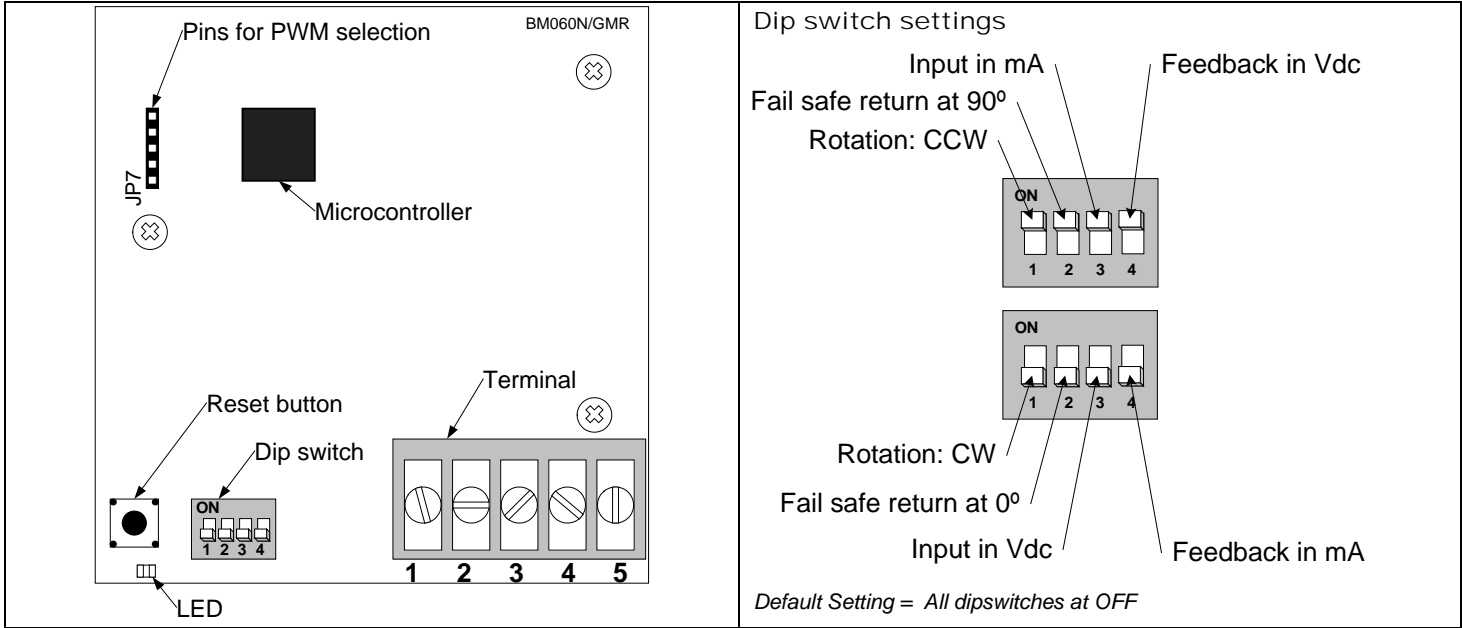

Stroke adjustment – No control signal change

1. Apply power and, **WAIT FOR LED TO BE OFF (around 10 seconds)**.
2. Press and release the reset button to start the auto-stroke process. The LED should be illuminated.
 - **First option:**
The actuator will then travel in both directions to find its limit and position itself according to the demand. The LED will extinguish, the process is complete.
 - **Second option:**
When the desired start position is reached, press and release the reset button. The actuator will now go the end position. (you can also press and release the reset button when it reaches the end position) The LED will extinguish, the process is complete.

Programming – Change of control signal & PWM pulse setting

1. Remove power and put all dip switches "OFF" (default setting).
 2. Apply power and, **within 10 seconds**, press and release the reset button. The LED should be blinking.
 3. Select the control signal with dip switches:
- | | Digital or Analog Modes | PWM Mode |
|---|---|--------------------------------|
| Move switch No1 "ON" and then "OFF". | Digital (On/Off or 3 point floating) | 5 sec. pulse (default setting) |
| Move switch No2 "ON" and then "OFF". | Analog (Default) | 25 sec. pulse |
- Stroke adjustment
see the stroke adjustment section above.

Enabling or disabling PWM mode

1. Remove power supply to actuator
 2. Install jumper between pin 3 & 4 of JP7
 3. Select the desired action using the dipswitches (DS1):

DS1-1	DS1-2	Action
OFF	ON	Enable PWM Mode
ON	OFF	Disable PWM Mode
 4. Re-apply power supply to actuator
 5. **Wait 5 seconds**
 6. Remove power supply to actuator
 7. Remove jumper between pin 3 & 4 of JP7, re-install it between pin 4 & 5.
 8. Re-apply power supply to actuator
PWM is factory preset at 5 sec. pulse, refer to programming section above to change pulse setting.
-

Zero and span calibration

This feature is applicable to analog control signal only.

1. Remove power and put all dip switches "OFF". (factory preset).
2. Apply power and, **within 10 seconds** press and **hold** the reset button until the LED blinks once. The Zero and span calibration process then start.
3. Release the reset button. The LED is now constantly illuminated.
4. Apply new minimum voltage.
It can be any value between 0 to 7 Vdc, with an external 0 to 10 volt supply (ex: MEP).
5. Press and release the reset button to memorize the new minimum voltage. The LED blinks.
6. Apply new maximum voltage.
It can be any value between 3 to 10 Vdc, this value should be greater than the new minimum value.
7. Press and release the reset button to memorize the new maximum voltage. The LED blinks. The Zero and span calibration process is complete.

Note: To reset zero and span to 2 to 10 Vdc (default setting). You just have to re-select the analog control signal mode, see Programming.

Wiring Diagrams for auxiliary switches (on model 020)

