



Specification & Installation instruction



Feature:

- Power supply high voltage 120 or 240 VAC.
- Clutch for manual adjustments.
- Maintenance free.
- Position indicator.
- Fail safe by *Enerdrive System*¹ (on model 360 & 380).
- Auxiliary switches (on model 320 & 380).

Old Number

<i>TBTHV3300A</i>	TT300
<i>TBTHV3305A</i>	TT305
<i>TBTHV3321A</i>	TT320
<i>TBTHV3360A</i>	TT360
<i>TBTHV3365A</i>	TT365
<i>TBTHV3380A</i>	TT380
<i>RBTHV5300A</i>	RT300
<i>RBTHV5305A</i>	RT305
<i>RBTHV5321A</i>	RT320
<i>RBTHV5360A</i>	RT360
<i>RBTHV5365A</i>	RT365
<i>RBTHV5380A</i>	RT380

Technical Data	TT300 <i>TBTHV 3300A</i>	TT305 <i>TBTHV 3305A</i>	TT320 <i>TBTHV 3321A</i>	TT360 <i>TBTHV 3360A</i>	TT365 <i>TBTHV 3365A</i>	TT380 <i>TBTHV 3380A</i>	RT300 <i>RBTHV 5300A</i>	RT305 <i>RBTHV 5305A</i>	RT320 <i>RBTHV 5321A</i>	RT360 <i>RBTHV 5360A</i>	RT365 <i>RBTHV 5365A</i>	RT380 <i>RBTHV 5380A</i>
Auxiliary switches	No	No	Yes(2)	No	No	Yes (2)	No	No	Yes(2)	No	No	Yes (2)
Feedback	No	Yes	No	No	Yes	No	No	Yes	No	No	Yes	No
Fail safe - Enerdrive	No			Yes			No			Yes		
Power consumption	10 VA			30 VA Peak, 10 VA			14 VA			30 VA Peak, 14 VA		
Control signal	3 wire / 2 position, 3 wire / 3 point floating			2 wire / 2 position, 4 wire / 3 point floating			3 wire / 2 position, 3 wire / 3 point floating			2 wire / 2 position, 4 wire / 3 point floating		
Weight	5 lbs. [2.3 kg]						8 lbs. [3.5 kg]					
Torque	180 in.lb. [20 Nm] at rated voltage						360 in.lb. [40 Nm] at rated voltage					
Running time through 90°	60 to 85 sec Torque dependant											
Power supply	110 to 130 VAC or 220 to 250 VAC 50/60Hz											
Electrical connection	18 AWG [0.8 mm ²] minimum											
Inlet bushing	2 inlet bushing of 7/8 in [22.2 mm]											
Angle of rotation	0 to 90 degrees, mechanically adjustable with SLD (optional), (factory set with 90° stroke)											
Direction of rotation	Reversible, Clockwise (CW) or Counterclockwise (CCW) (factory set with CW direction)											
Ambient temperature	0°F to +122°F [-18° C to +50° C]											
Storage temperature	-22°F to +122°F [-30° C to +50° C]											
Relative Humidity	5 to 95 % non condensing.											

Warning: Do not press the clutch when actuator is powered

Dimensions

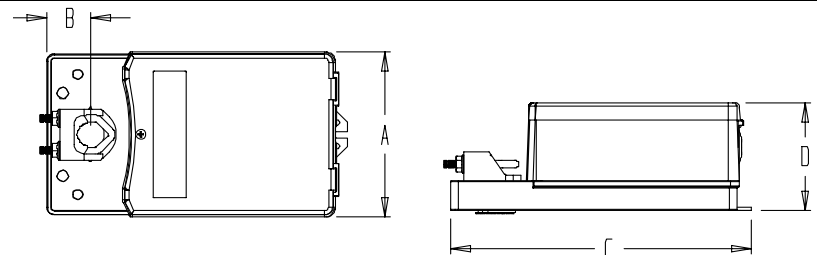

Dimension	Inches	Metric (mm)
A	5.20	132.1
B	1.33	33.8
C	9.13	231.9
D	3.55	90.2

Caution

We strongly recommend that all neptronic® products be wired to a separate transformer and that transformer shall service only neptronic® products. This precaution will prevent interference with, and/or possible damage to incompatible equipment.
When multiple actuators are wired on a single transformer, polarity must be observed. Long wiring runs create voltage drop which may affect the actuator performance.

¹ Enerdrive System U.S.A. Patent #5,278,454



Mechanical installation

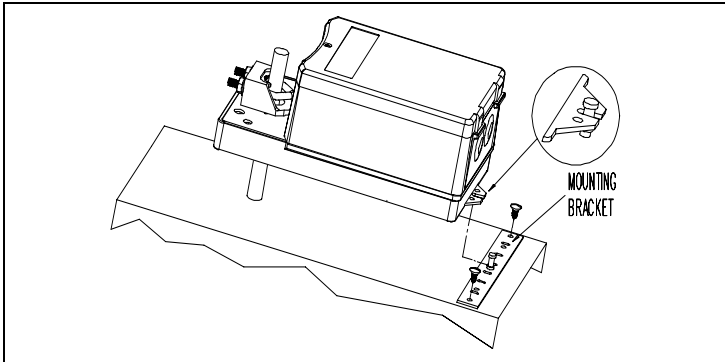

1. Manually close the damper blades and positioned the actuator at 0° or 90°.
2. Slide the actuator onto the shaft.
3. Tighten the nuts on the “U” bolt to the shaft with a 10mm wrench to a torque of 150 in.lb. [17 Nm].
4. Slide the mounting bracket under the actuator. Ensure free movement of the slot at the base of the actuator. The bracket pin must be placed in the mid distance of the slot.
5. Fix the bracket to the ductwork with #8 self-tapping screws.

Wiring Diagrams

Models TT300, 305 & 320
RT300, 305 & 320

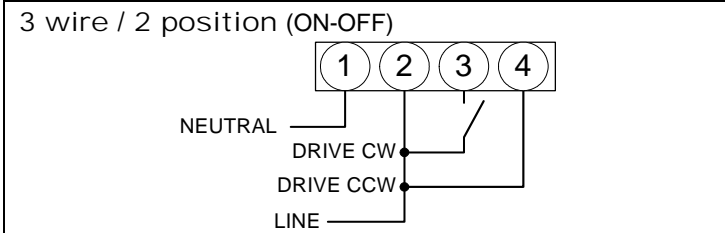

Models TT360, 365 & 380
RT360, 365 & 380

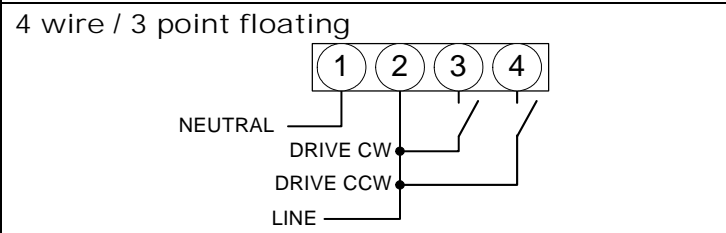
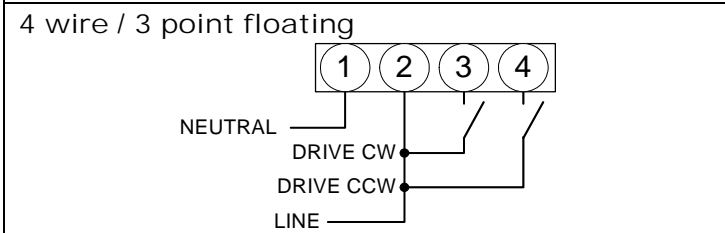
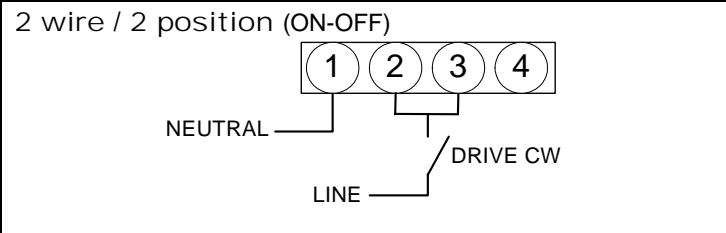

PC Board

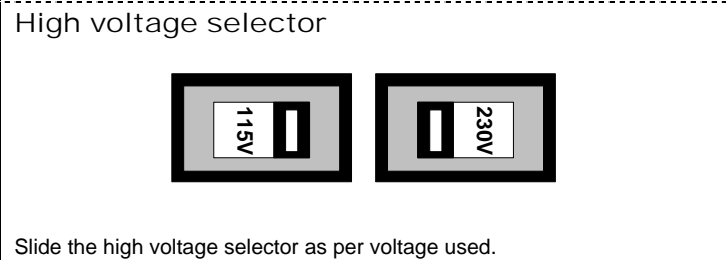
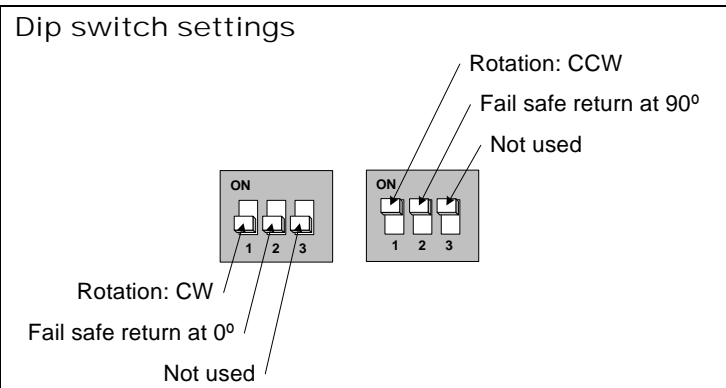
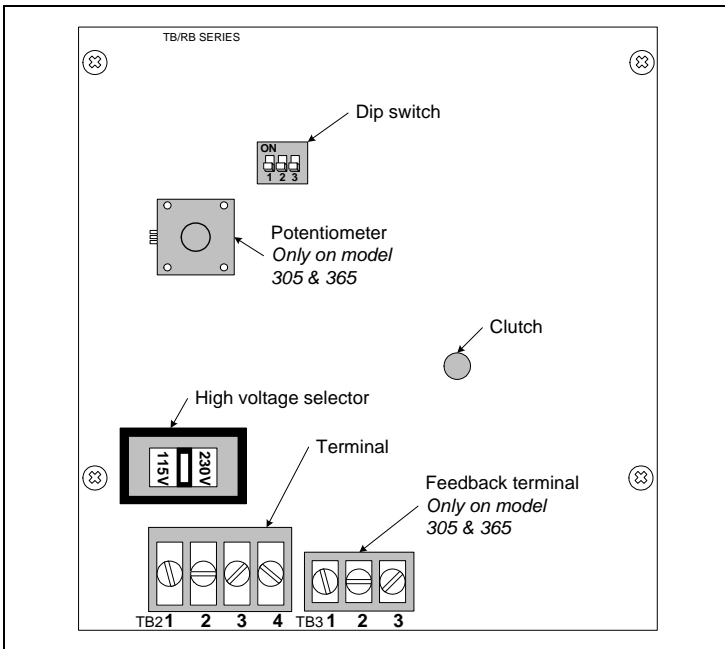

Stroke adjustment

To adjust the stroke, use the stroke limiting device (SLD). (not included)